

BIO323 // Long 6.0 Liter Bioethanol Burner

Technical Specifications

Fireplace Type	Bioethanol Burner
Fuel	Bioethanol, max. 97.5% alcohol
Weight	15 kg.
Materials	Stainless Steel
Size	Height: 80 / Width: 1200 / Depth: 160 mm.
Colour	Steel
Burner type	Manual
Capacity	6.0 liter
Adjustable flame	Yes
Burn time	Up to 6h00m
Requires electricity	No
Heat effect	8.61 kW/h

Pictures



Technical Drawings

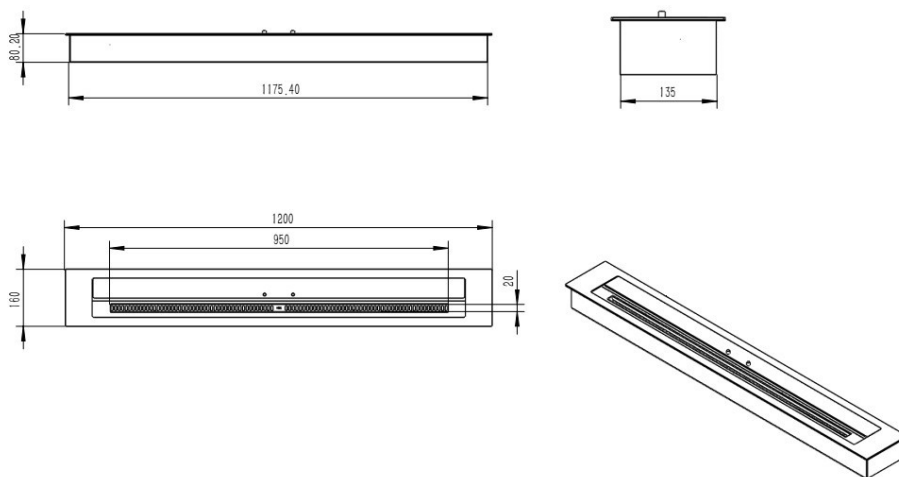

www.biofireplacegroup.com

Date of publication: 24/09-2018